

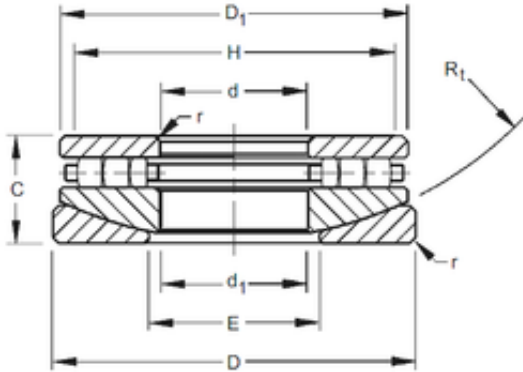

SMITH BEARING MEXICO LTD

Timken 60TPS125 Rolamentos de rolos



Bearing No. 60TPS125

Bore Diameter	152,4 mm
Outer Diameter	266,7 mm
d	152,4 mm
D	266,7 mm
r max	3,2 mm
d1	155,58 mm
C	66,675 mm
D1	252,46 mm
E	187,3 mm
H	241,3 mm
R	241,3 mm

60TPS125 Bearing 2D drawings and 3D CAD models